

AÇO INOX

Suportes capeados p/ vidro temperado

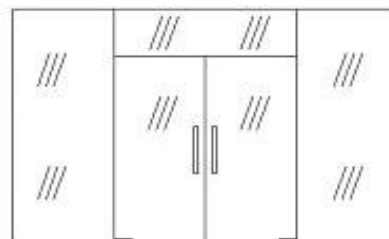
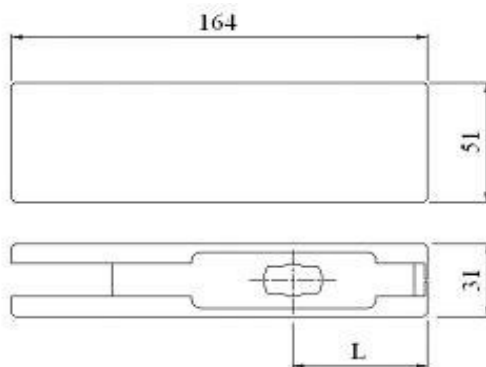

PT01 - PF001

Dorma : L= 55
New Star: L= 60

CÓDIGO	VIDRO	MATERIAL	CONEXÃO
AC-PT01/DSS Dorma	10 mm	INOX AISI 304 ESCOVADO	PT04 ; MOLA PAVIMENTO
AC-PT01/NSS New Star	10 mm	INOX AISI 304 ESCOVADO	PT04 ; MOLA PAVIMENTO

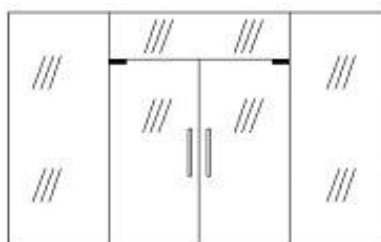
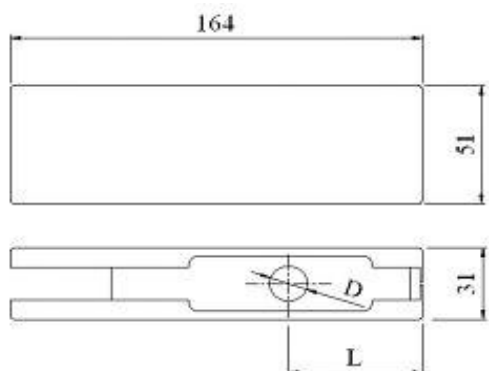
PT02 - PF002

Dorma: D=15 L= 50 - 55
New Star: D=12 L= 50 - 58

CÓDIGO	VIDRO	MATERIAL	CONEXÃO
AC-PT02/DSS Dorma	10 mm	INOX AISI 304 ESCOVADO	PT03; PT05; PT07; PT39; PT40; PT41
AC-PT02/NSS New Star	10 mm	INOX AISI 304 ESCOVADO	PT03; PT05; PT07; PT39; PT40; PT41

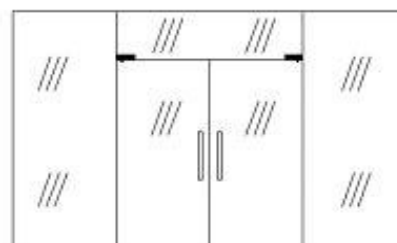
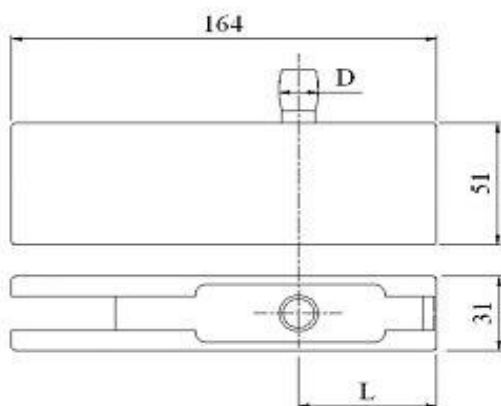
PT03 - PF003

Dorma: D=14,8 L= 50 - 55
New Star: D=11 L= 50 - 55

CÓDIGO	VIDRO	MATERIAL	CONEXÃO
AC-PT03/DSS Dorma	10 mm	INOX AISI 304 ESCOVADO	PT02
AC-PT03/NSS New Star	10 mm	INOX AISI 304 ESCOVADO	PT02

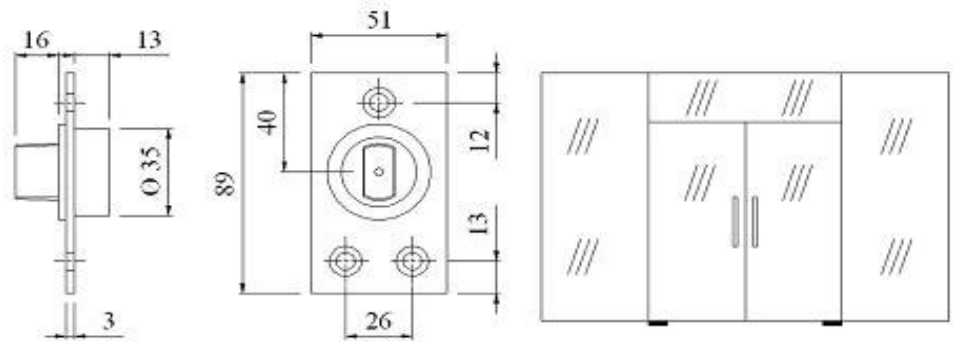
PT04 - CMH160

DORMA

CÓDIGO	VIDRO	MATERIAL	CONEXÃO
AC-PT04/SS		INOX AISI 304 ESCOVADO	PT01 ; PT29

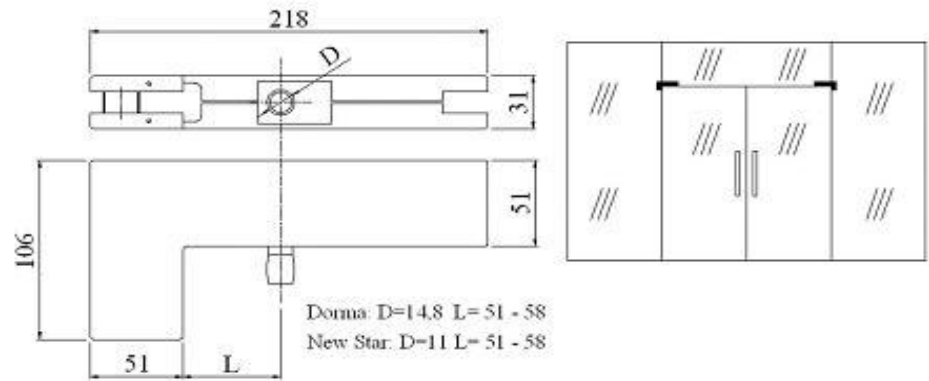
PT05 - PF004

CÓDIGO	VIDRO	MATERIAL	CONEXÃO
AC-PT05/SS	10 mm	INOX AISI 304 ESCOVADO	PT02

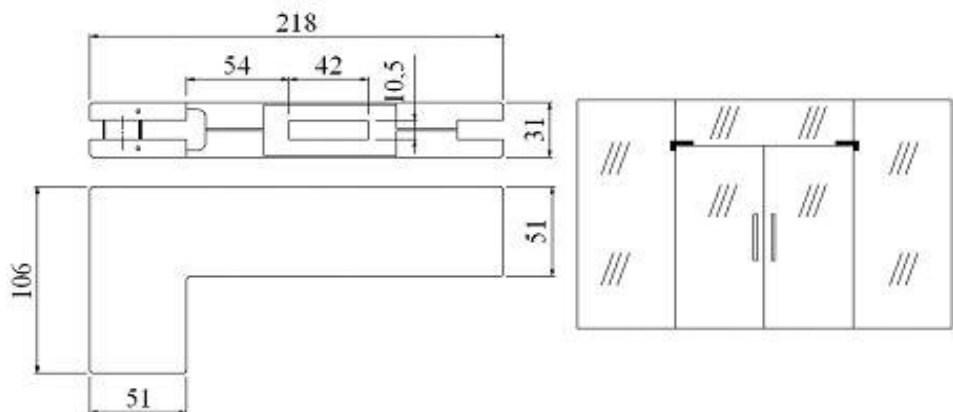
PT06 - PF013

CÓDIGO	VIDRO	MATERIAL	CONEXÃO
AC-PT06/SS	10 mm	INOX AISI 304 ESCOVADO	PT37

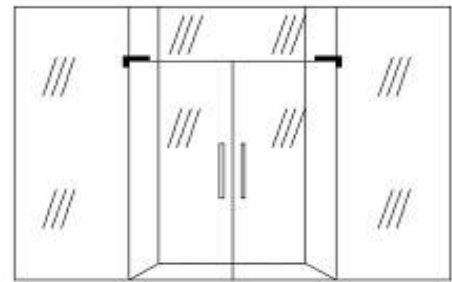
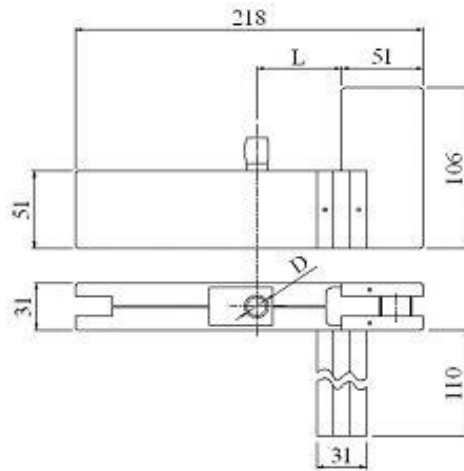
PT07 - PF031

Doma: D=14,8 L= 55 - 70

CÓDIGO	VIDRO	MATERIAL	CONEXÃO
AC-PT07/SSD Direita	10 mm	INOX AISI 304 ESCOVADO	PT02
AC-PT07/SSE Esquerda	10 mm	INOX AISI 304 ESCOVADO	PT02

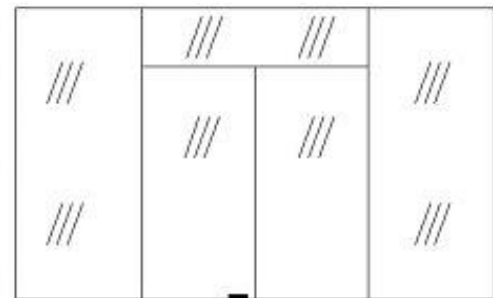
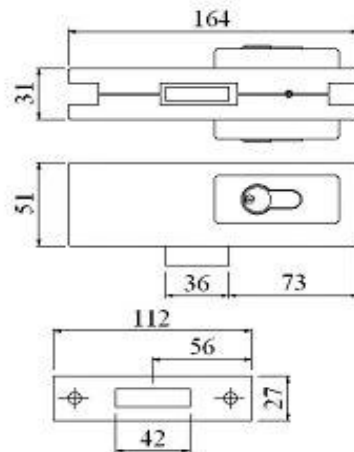
PT09 - KG90

CÓDIGO	VIDRO	MATERIAL	CONEXÃO
AC-PT09/SS	10 mm	INOX AISI 304 ESCOVADO	PT38

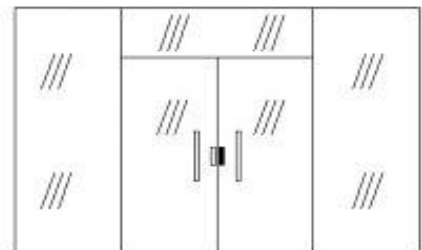
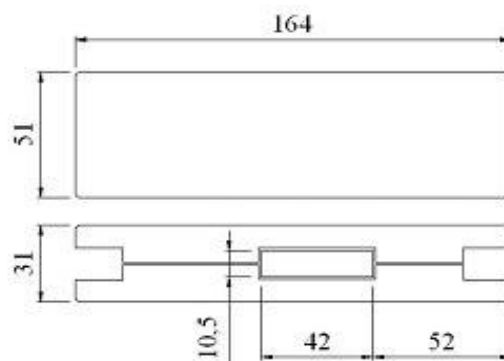
PT10 - PF006K

CÓDIGO	VIDRO	MATERIAL	CONEXÃO
AC-PT10/SS	10 mm	INOX AISI 304 ESCOVADO	PT37

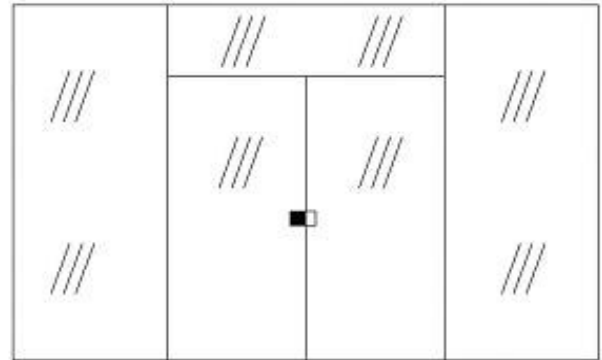
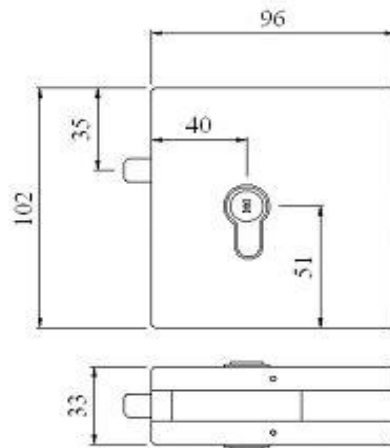
PT14

CÓDIGO	VIDRO	MATERIAL	CONEXÃO
AC-PT14/SS	10 mm	INOX AISI 304 ESCOVADO	PT15

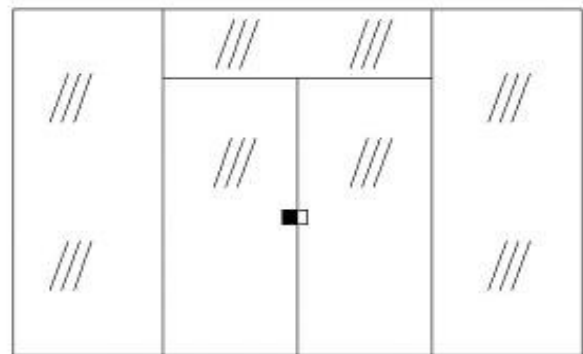
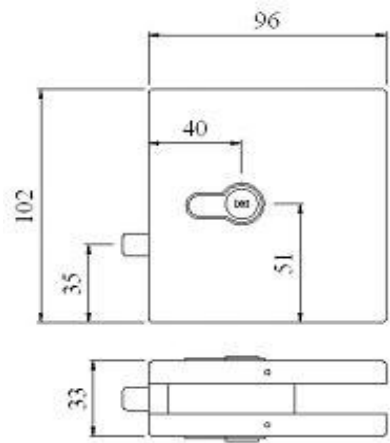
PT14 - PF017

CÓDIGO	VIDRO	MATERIAL	CONEXÃO
AC-PT14/SS	10 mm	INOX AISI 304 ESCOVADO	PT15

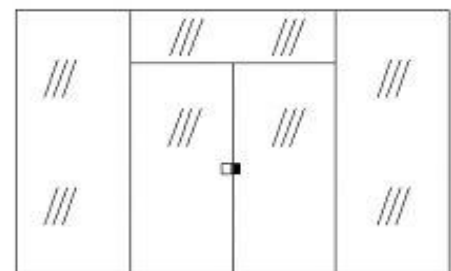
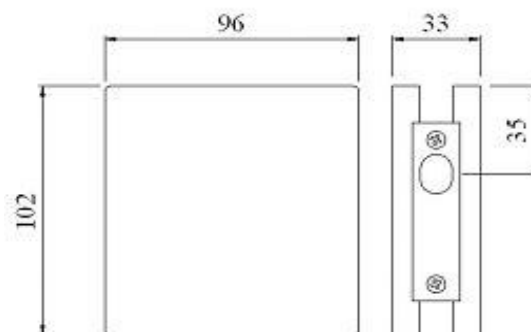
PT15 - PF018

CÓDIGO	VIDRO	MATERIAL	CONEXÃO
AC-PT15/SS	10 mm	INOX AISI 304 ESCOVADO	PT14

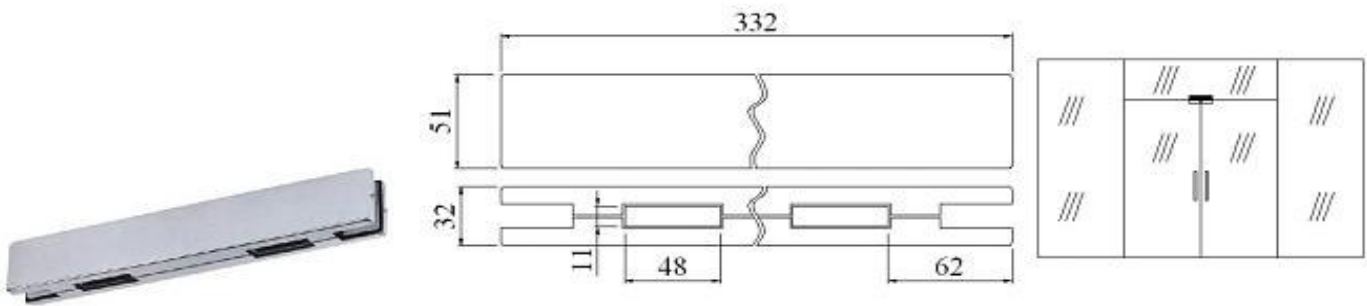
PT17 - PF012

CÓDIGO	VIDRO	MATERIAL	CONEXÃO
AC-PT17/SS	10 mm	INOX AISI 304 ESCOVADO	PT 37

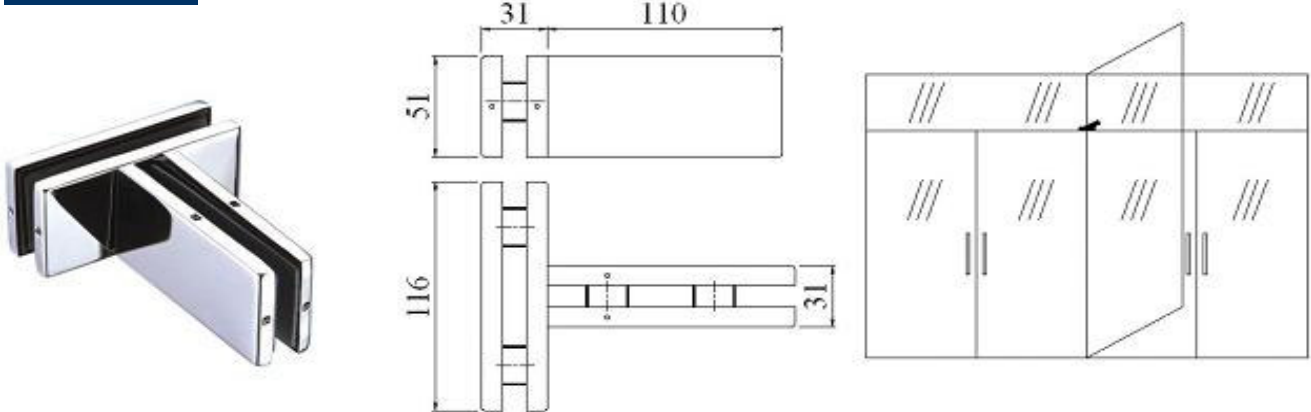
PT18 - PF034

CÓDIGO	VIDRO	MATERIAL	CONEXÃO
AC-PT18/SS	10 mm	INOX AISI 304 ESCOVADO	

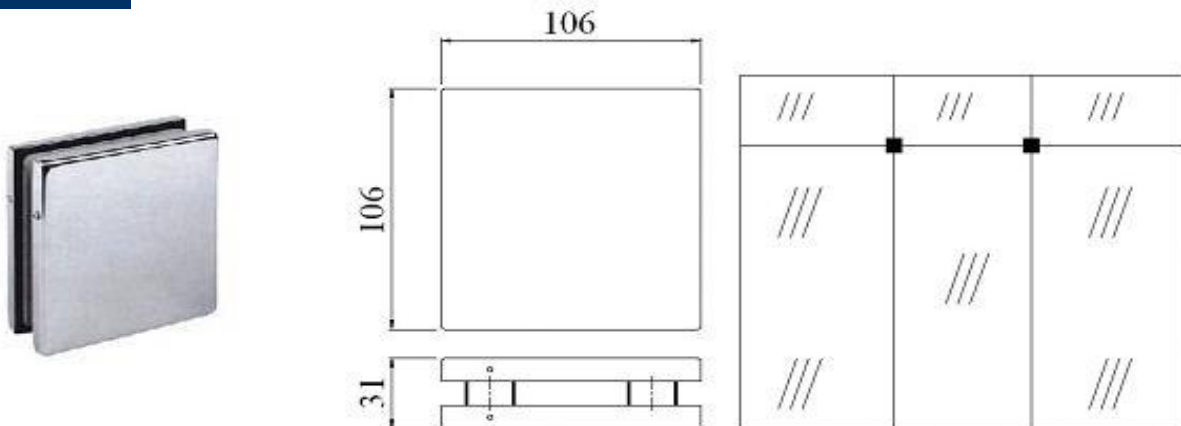
PT19 - PF021

CÓDIGO	VIDRO	MATERIAL	CONEXÃO
AC-PT19/SS	10 mm	INOX AISI 304 ESCOVADO	

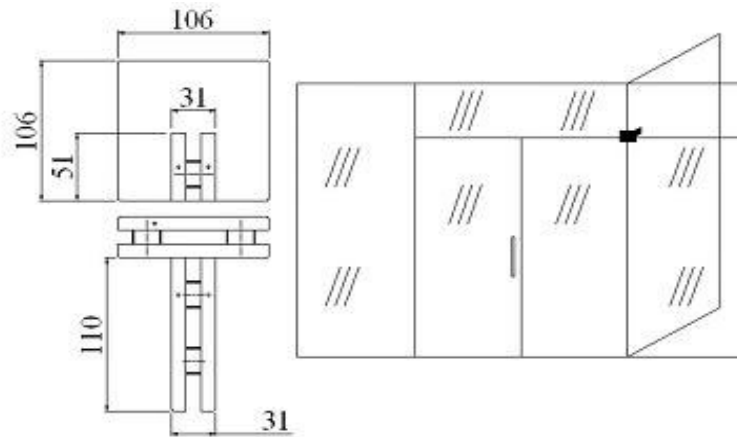
PT20 - PF022

CÓDIGO	VIDRO	MATERIAL	CONEXÃO
AC-PT20/SS	10 mm	INOX AISI 304 ESCOVADO	

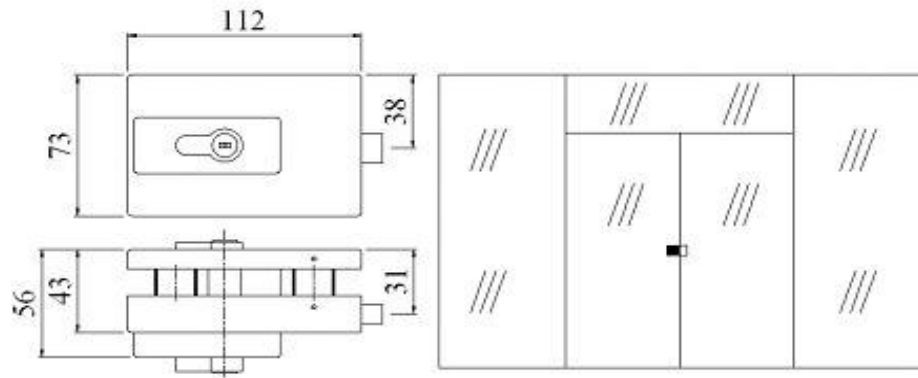
PT21 - PF024

CÓDIGO	VIDRO	MATERIAL	CONEXÃO
AC-PT21/SS	10 mm	INOX AISI 304 ESCOVADO	PT22

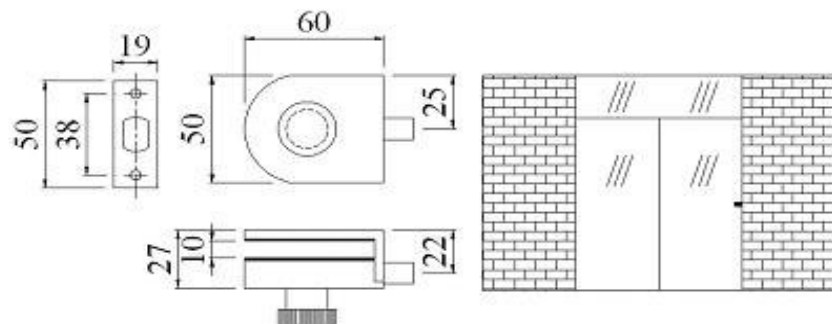
PT24

CÓDIGO	VIDRO	MATERIAL	CONEXÃO
AC-PT24/SS	10 mm	INOX AISI 304 ESCOVADO	
AC-PT24/PS	10 mm	LATÃO CROMADO	

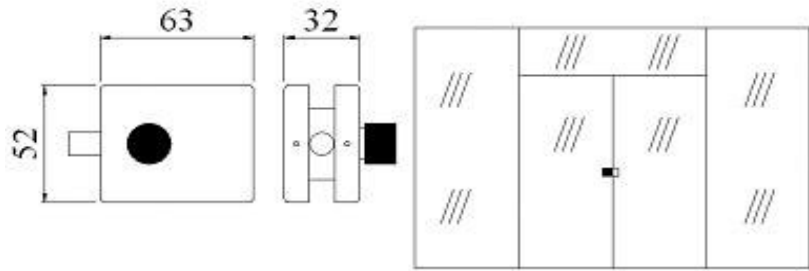
PT25 - PF015

CÓDIGO	VIDRO	MATERIAL	CONEXÃO
AC-PT25/SS	10 mm	INOX AISI 304 ESCOVADO	PT26

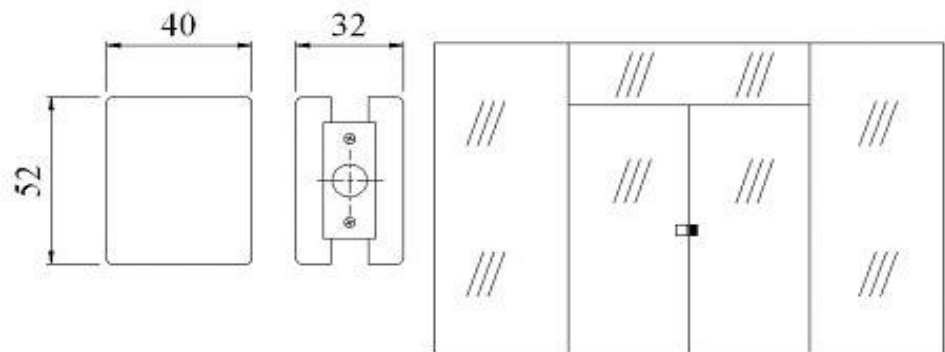
PT26 - PF016

CÓDIGO	VIDRO	MATERIAL	CONEXÃO
AC-PT26/SS	10 mm	INOX AISI 304 ESCOVADO	PT25

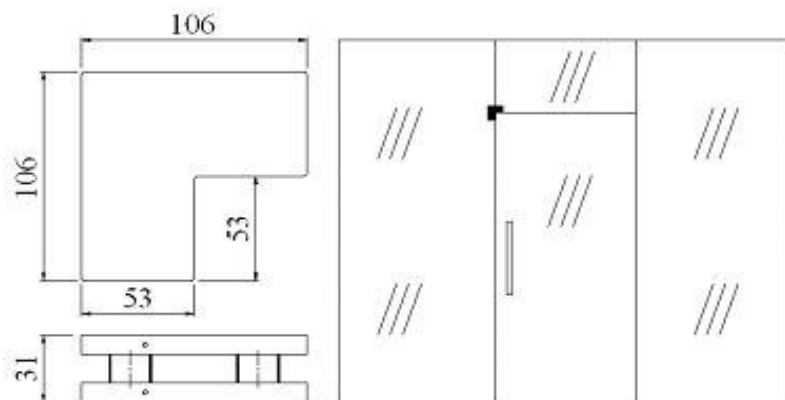
PT27 - PF026

CÓDIGO	VIDRO	MATERIAL	CONEXÃO
AC-PT27/SS	10 mm	INOX AISI 304 ESCOVADO	

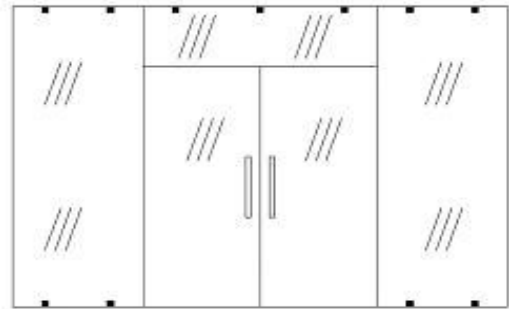
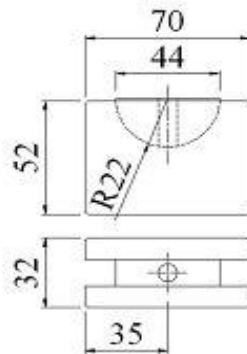
AC-PT28

CÓDIGO	VIDRO	MATERIAL	CONEXÃO
AC-PT28/SS	10 mm	INOX AISI 304 ESCOVADO	

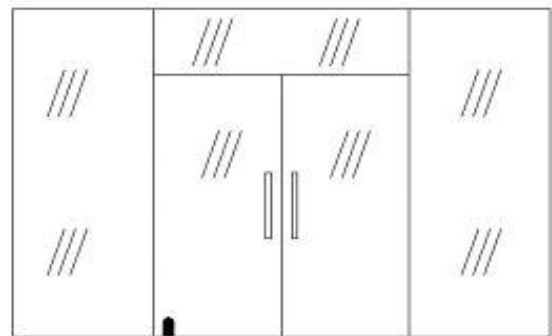
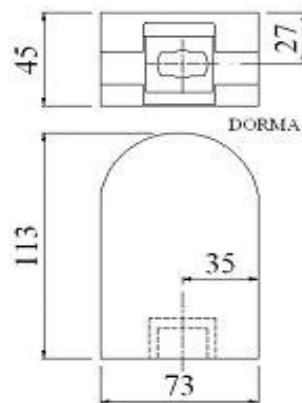
PT29 - PF007

CÓDIGO	VIDRO	MATERIAL	CONEXÃO
AC-PT29/SS	10 mm	INOX AISI 304 ESCOVADO	PT04; MOLA PAVIMENTO

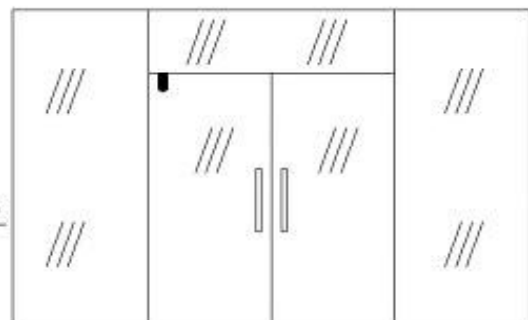
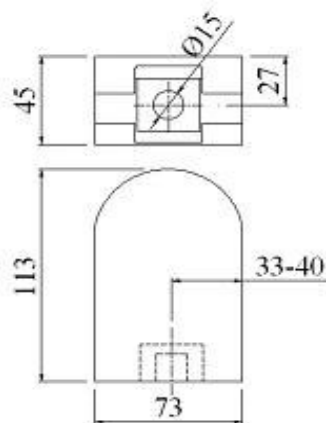
PT30 - PF009

CÓDIGO	VIDRO	MATERIAL	CONEXÃO
AC-PT30/SS	10 mm	INOX AISI 304 ESCOVADO	PT31

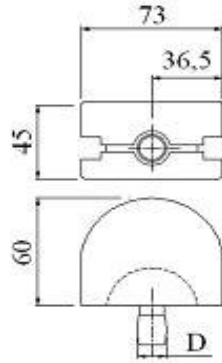
PT31 - PF011

Dorma: D=14,8
New Star: D=11

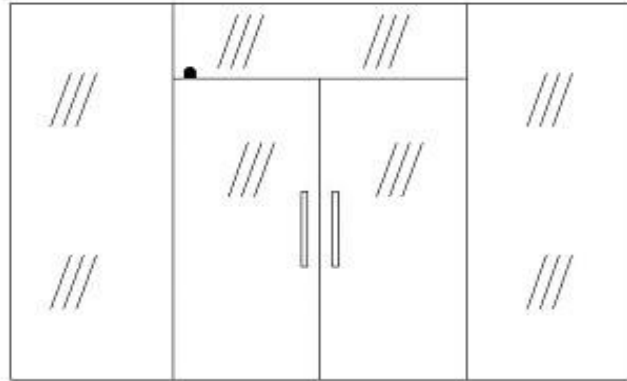

CÓDIGO	VIDRO	MATERIAL	CONEXÃO
AC-PT31/SS	10 mm	INOX AISI 304 ESCOVADO	PT30

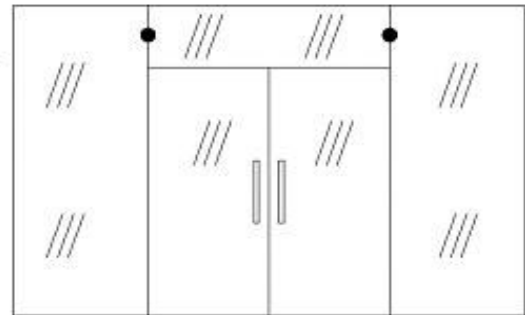
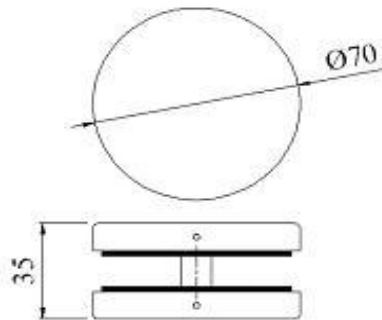
PT32 - PF008

CÓDIGO	VIDRO	MATERIAL	CONEXÃO
AC-PT32/SS	10 mm	INOX AISI 304 ESCOVADO	

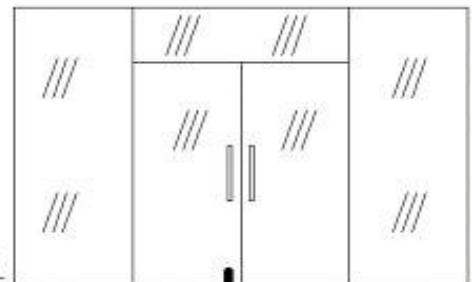
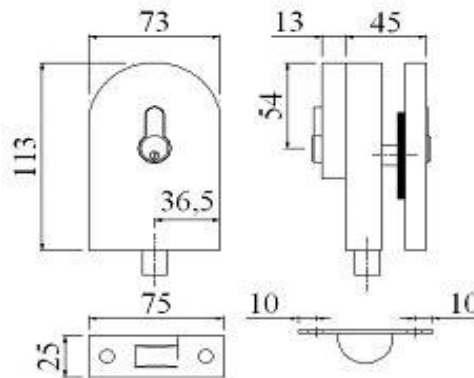
PT33 - PF010

CÓDIGO	VIDRO	MATERIAL	CONEXÃO
AC-PT33/SS	10 mm	INOX AISI 304 ESCOVADO	

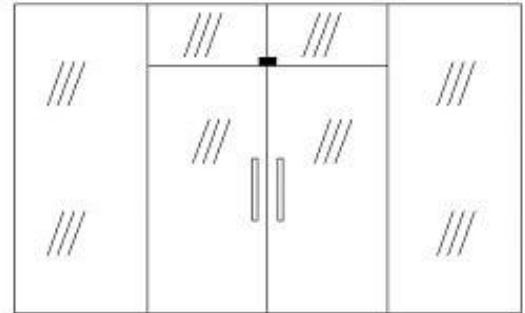
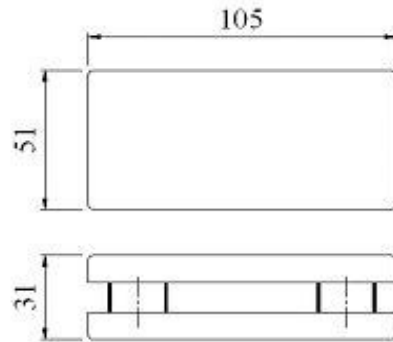
PT34 - PF020

CÓDIGO	VIDRO	MATERIAL	CONEXÃO
AC-PT34/SS	10 mm	INOX AISI 304 ESCOVADO	

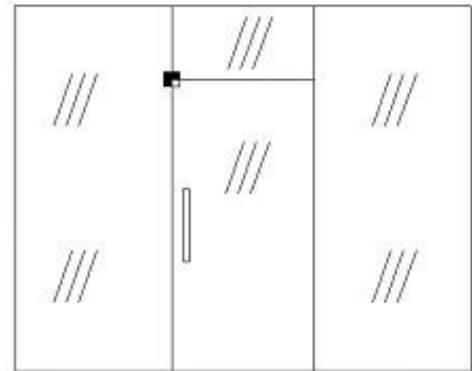
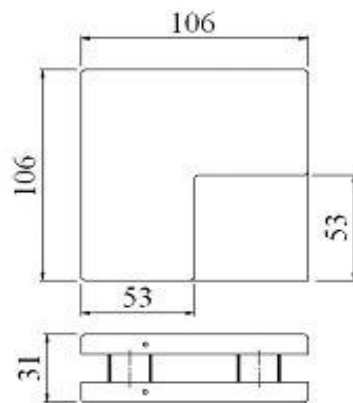
PT35 - PF027

CÓDIGO	VIDRO	MATERIAL	CONEXÃO
AC-PT35/SS	10 mm	INOX AISI 304 ESCOVADO	

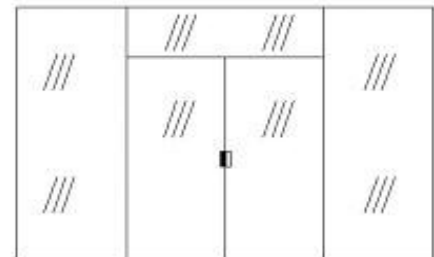
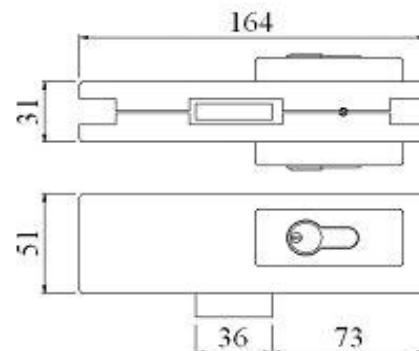
PT37 - PF006

CÓDIGO	VIDRO	MATERIAL	CONEXÃO
AC-PT37/SS	10 mm	INOX AISI 304 ESCOVADO	PT10; PT06; PT38

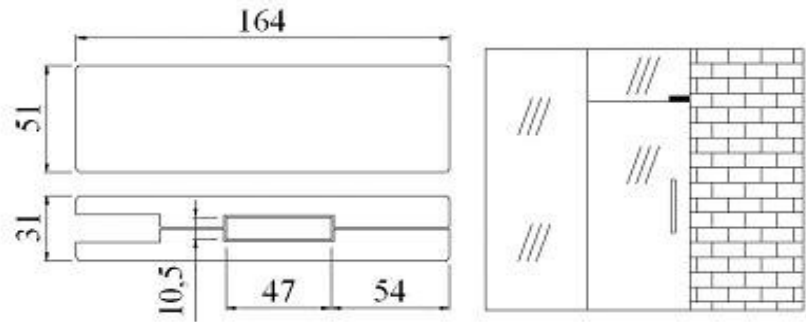
PT38 - PF025

CÓDIGO	VIDRO	MATERIAL	CONEXÃO
AC-PT38/SS	10 mm	INOX AISI 304 ESCOVADO	PT09; PT37

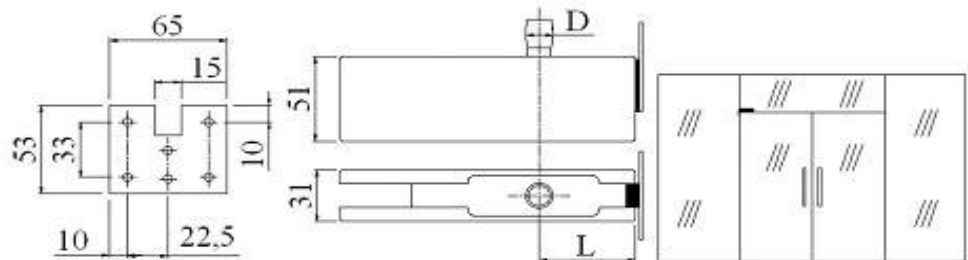
PT39

Dorma: D=14,8 L= 50 - 55
New Star: D=11 L= 50 - 55

CÓDIGO	VIDRO	MATERIAL	CONEXÃO
AC-PT39/SS	10 mm	INOX AISI 304 ESCOVADO	PT02
AC-PT39/PS	10 mm	INOX AISI 304 POLIDO	PT02

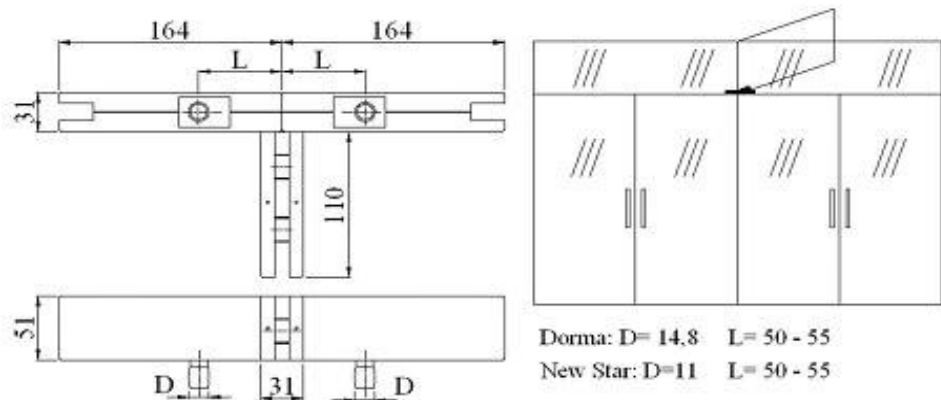
PT40 - PF029

Dorma: D= 14,8 L= 50 - 55
New Star: D=11 L= 50 - 55

CÓDIGO	VIDRO	MATERIAL	CONEXÃO
AC-PT40/SS	10 mm	INOX AISI 304 ESCOVADO	PT02

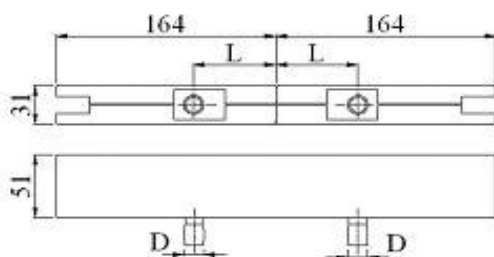
PT41 - PF028

Dorma: D= 14,8 L= 50 - 55
 New Star: D=11 L= 50 - 55

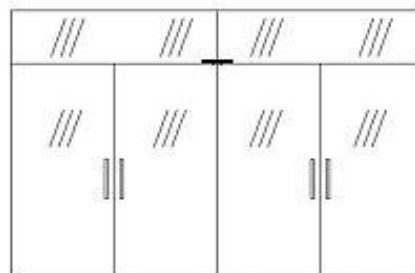

CÓDIGO	VIDRO	MATERIAL	CONEXÃO
AC-PT41/SS	10 mm	INOX AISI 304 ESCOVADO	PT02

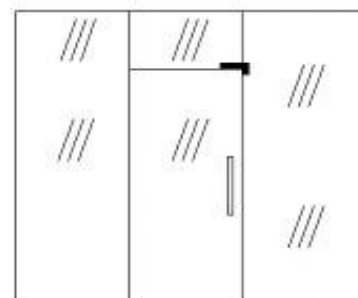
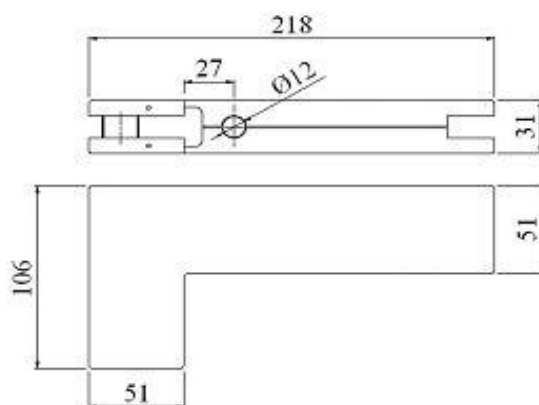
PT42 - PF014

CÓDIGO	VIDRO	MATERIAL	CONEXÃO
AC-PT42/SS	10 mm	INOX AISI 304 ESCOVADO	PT25